

DATE
Sept. 6, 2011
CAT. #: CD0306-50

OUTLINE DIMENSIONS
3-PHASE INDUCTION MOTOR

MOTOR TYPE:
AEEAGD
FRAME NO. 326T

Pole	HP	kW	Hz	VOLT	Syn. Speed r/min(rpm)
6	30	22.4	50	190/380	1000

Ins	Rating	Dimension in	Approx Weight	Bearings
F	CONT.	inches	616 lbs.	DE: 6312 NDE: 6212

Totally Enclosed Fan-Cooled Type. Squirrel-Cage Rotor.

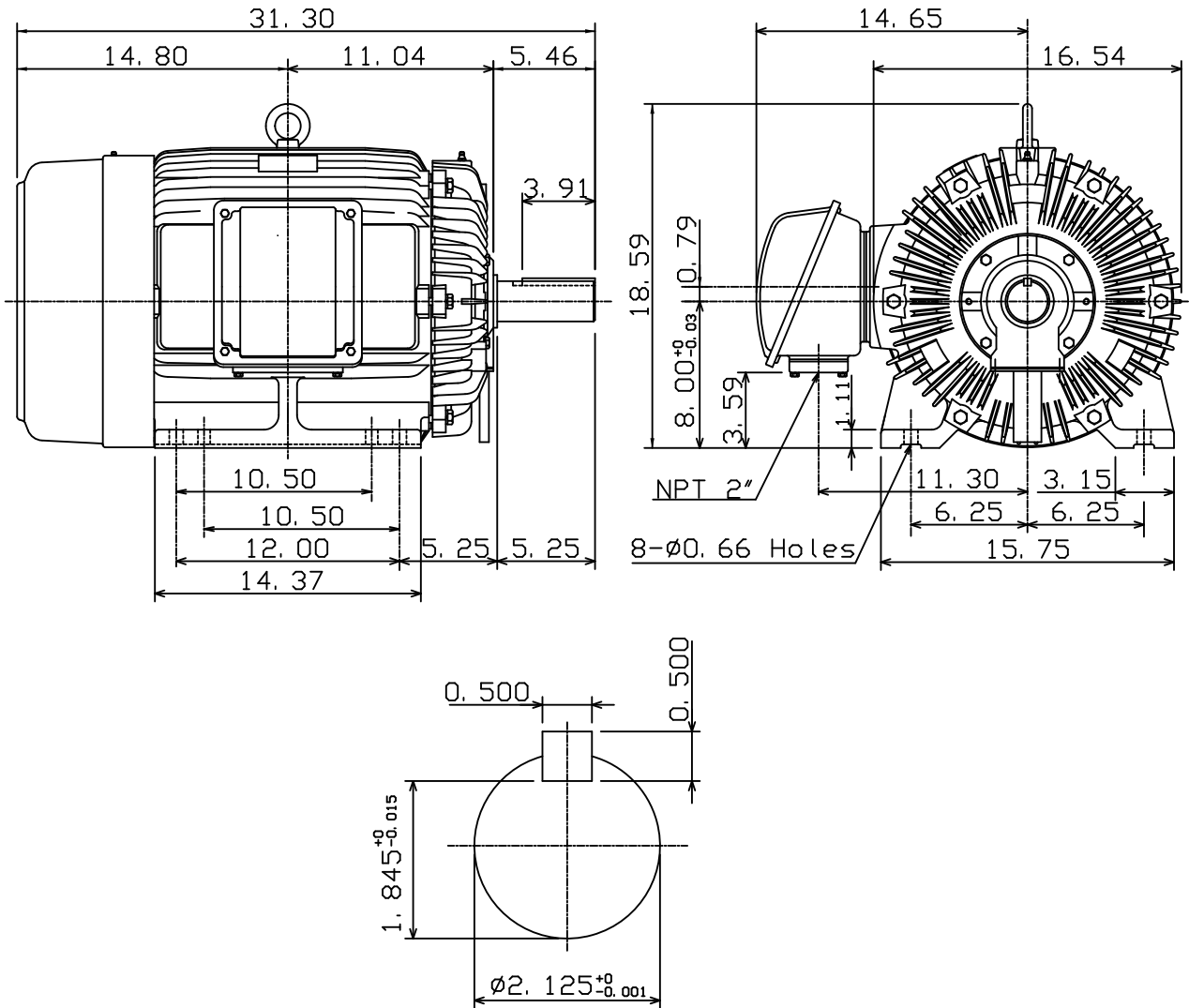

DWN. K. L. KUO 01-04-05
CHKD. C. H. KAO 01-28-05
APPD. M. C. TSAI 01-28-05



DWG NO.
31057H209440