

DATE
MAY 18, 2011
CATALOG NO.
XP0054

OUTLINE DIMENSIONS
3-PHASE INDUCTION MOTOR

MOTOR TYPE:
AEHHXU
FRAME NO. 184T

Pole	HP	KW	Hz	VOLT	Syn. Speed RPM
4	5	3.75	60	230/460	1800
Ins	Rating	Dimension in	Approx Weight	Bearings	
F	CONT.	inches	120 lbs.	DE: 6306ZZ	NDE: 6306ZZ

Totally Enclosed Fan-Cooled Type. Squirrel-Cage Rotor.

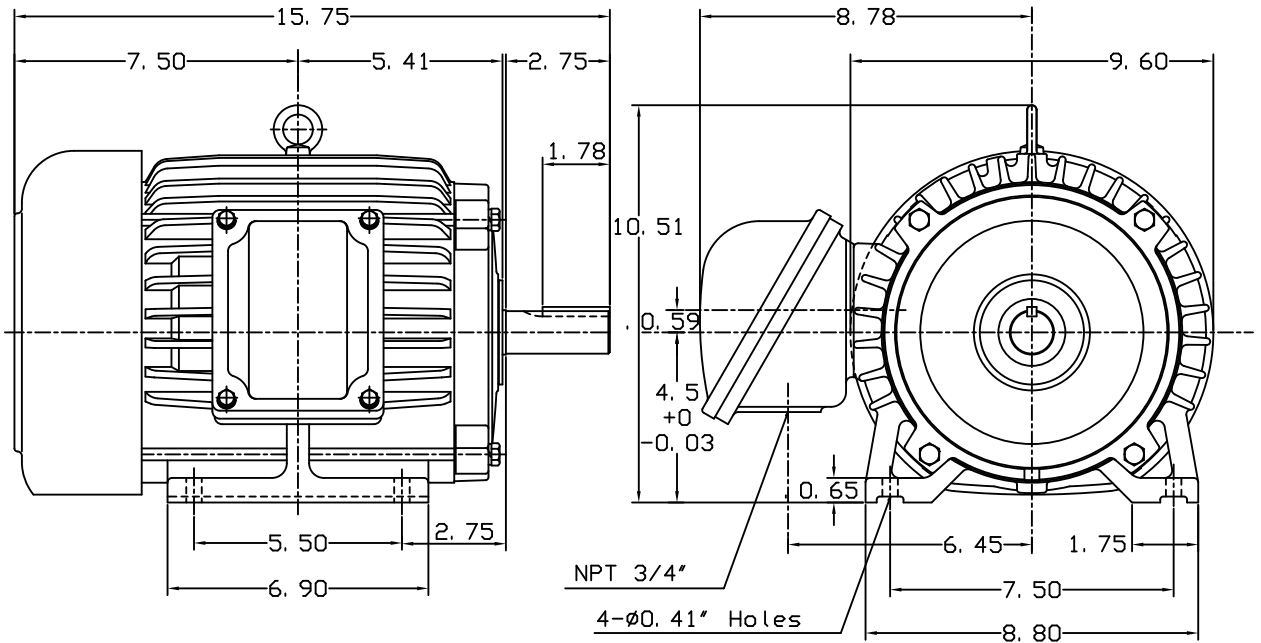

NOTE:
1. EXPLOSION PROOF:
CLASS I GROUP C, D AND
CLASS II GROUP E, F, G.



DWN.	J. H. LIANG	11-12-98
CHKD.	C. S. LO	11-23-98
APPD.	Y. B. HUANG	11-23-98

TECO Westinghouse

DWG NO.
31049H821032