

DATE  
Sept. 8, 2005  
CAT. #: EPO024-50

OUTLINE DIMENSIONS  
3-PHASE INDDUCTION MOTOR

MOTOR TYPE:  
AEHH8N  
FRAME NO. 145T

Pole	HP	kW	Hz	VOLT	Syn. Speed r/min(rpm)
4	2	1.5	50	190/380	1500

Ins	Rating	Dimension in	Approx Weight	Bearings
F	CONT.	inches	63 lbs.	DE: 6205ZZ NDE: 6205ZZ

Totally Enclosed Fan-Cooled Type. Squirrel-Cage Rotor.

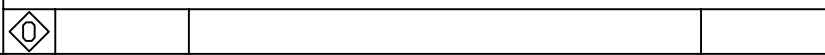
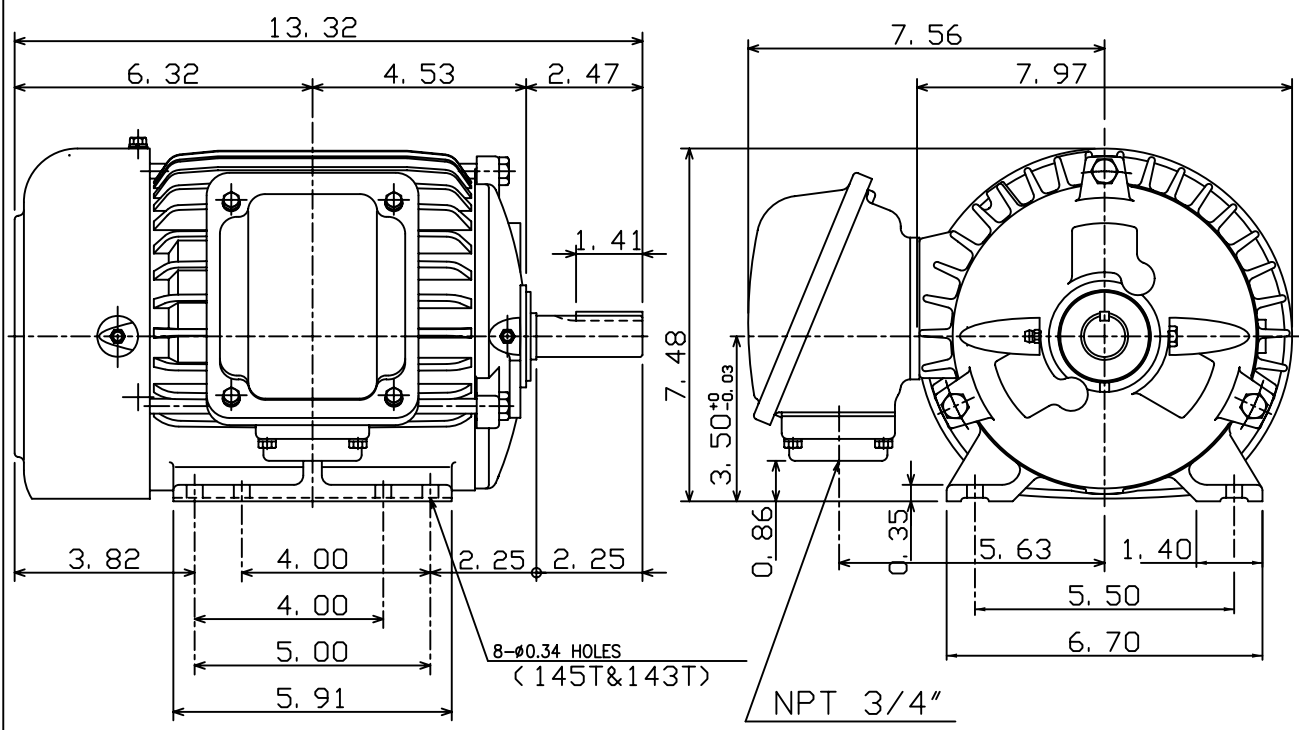

DWN.	C. S. LO	12-22-04
CHKD.	C. S. LO	12-27-04
APPD.	M. C. TSAI	12-27-04



DWG NO.  
31057H352080