

11

10

9

8

7

6

5

4

3

2

1

POLE	HP	kW	Hz	VOLT	r/min(RPM)	INS	RATING	DIMENSION IN	APPROX WEIGHT	BEARINGS
6	150	112	60	460	1200	F	CONT.	INCH	2059lbs	DE: 6320 NDE: 6316

G
F
E
D
C
B
A
第三角法
2

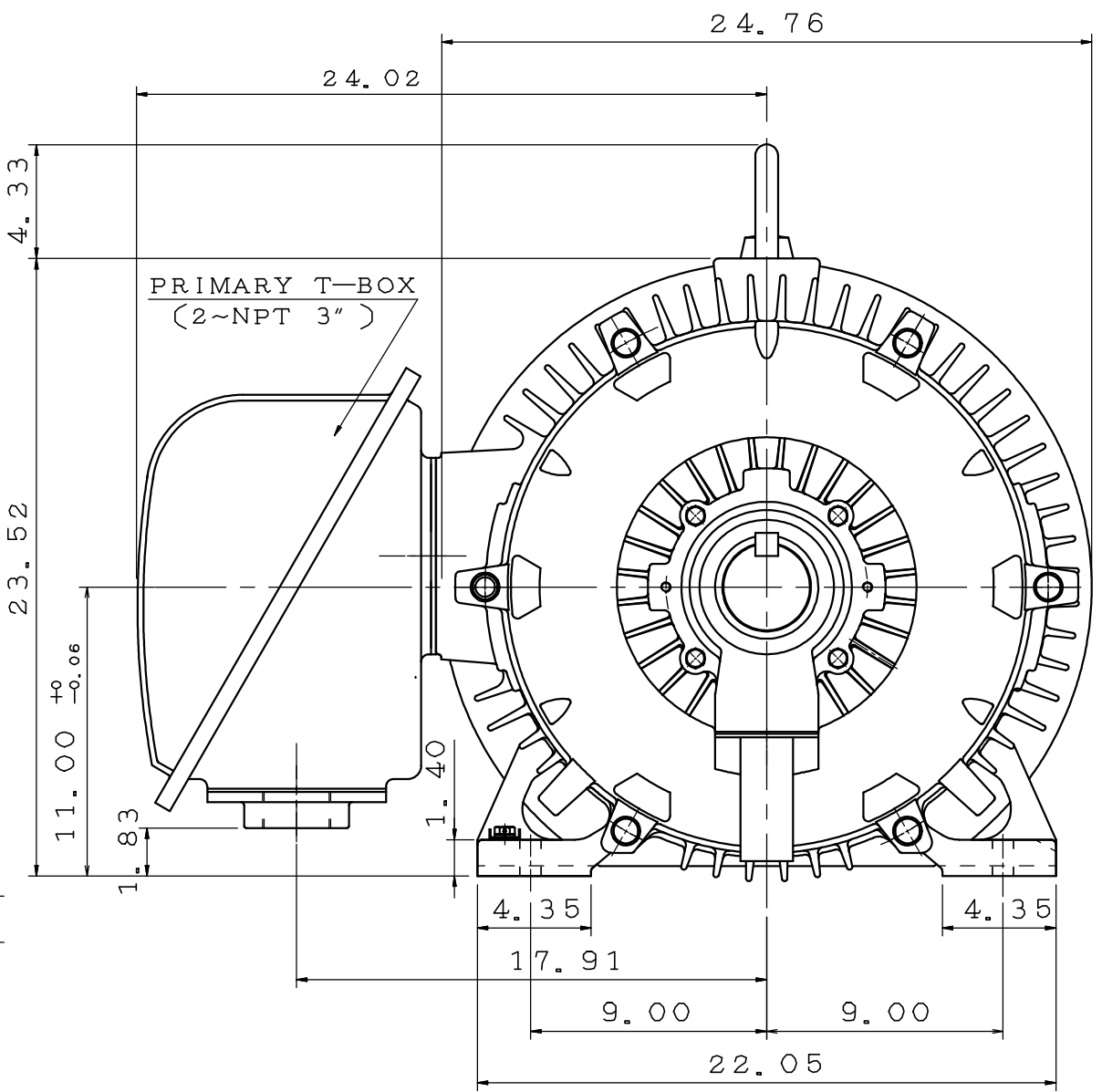
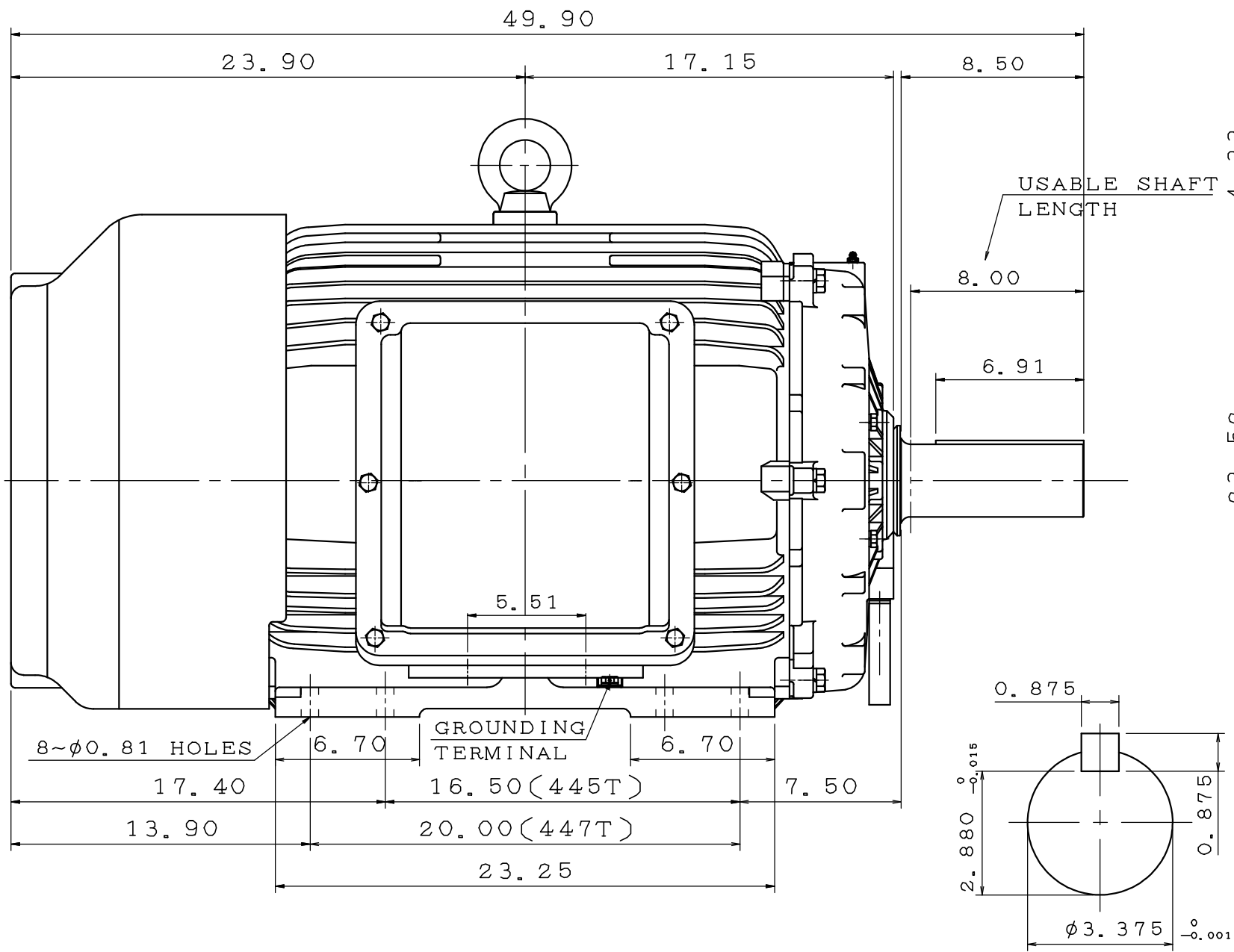

NOTE:
 1. FOR DIRECT FLEXIBLE COUPLING
 2. ENCLOSURE: IP55 PROTECTION

OUTLINE DIMENSIONS
 3-PHASE INDUCTION MOTOR

MOTOR TYPE	AEHH8N	FRAME NO.	447T
CATALOG NO:	EP1506	DATE	APRIL 1, 2020

APPD.	BEN. YANG	06•19•19
CHKD.	K. L. KUO	06•19•19
DWG.	K. L. KUO	06•15•19



DWG NO.
 31057C556650

11

10

9

8

7

6

5

4

3

2

1