

11

10

9

8

7

6

5

4

3

2

1

POLE	HP	kW	Hz	VOLT	r/min(RPM)	INS	RATING	DIMENSION IN	APPROX WEIGHT	BEARINGS
6	250	187	60	460	1200	F	CONT.	INCH	2466lbs	DE: 6320 NDE: 6316

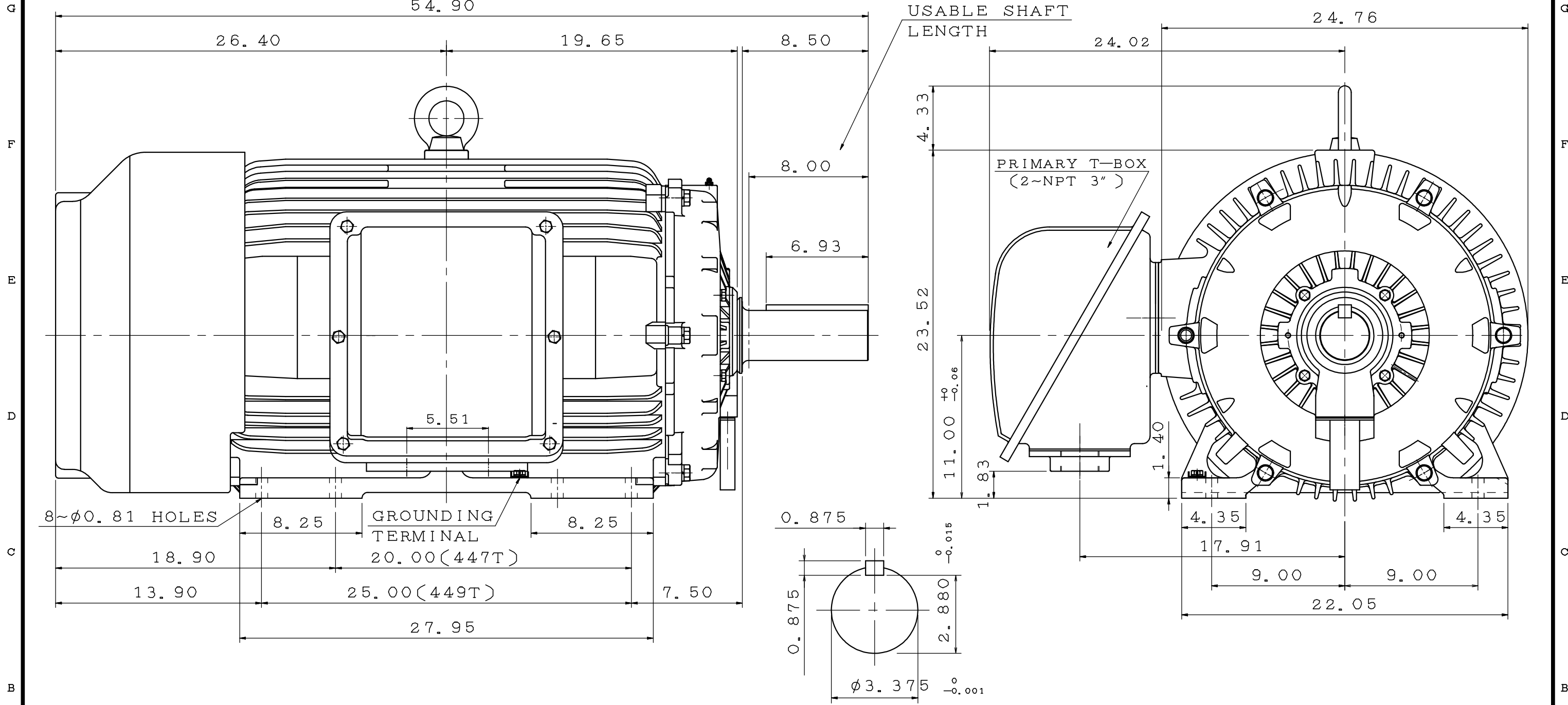

NOTE:
 1. FOR DIRECT FLEXIBLE COUPLING
 2. ENCLOSURE: IP55 PROTECTION

SHAFT END
ENLARGED VIEW

OUTLINE DIMENSIONS
3-PHASE INDUCTION MOTOR

MOTOR TYPE	AEHH8N	FRAME NO.	449T
CATALOG NO:	EP2506	DATE	APRIL 1, 2020

APPD.	BEN. YANG	06.19.19
CHKD.	K. L. KUO	06.19.19
DWG.	K. L. KUO	06.15.19

TECO Westinghouse

DWG NO.
31057C578240

第三角法

11

10

9

8

7

6

5

4

3

2

1