

DATE  
JUNE 21, 2005  
CATALOG NO.  
EP7/54-50

OUTLINE DIMENSIONS  
3-PHASE INDUCTION MOTOR

MOTOR TYPE:  
AEHH8N  
FRAME NO. 213T

Pole	HP	KW	Hz	VOLT	Syn. Speed RPM
4	7.5	5.6	50	190/380	1500

Ins	Rating	Dimension in	Approx Weight	Bearings
F	CONT.	inches	167 lbs.	DE: 6308ZZ NDE: 6306ZZ

Totally Enclosed Fan Cooled Squirrel Cage Rotor.

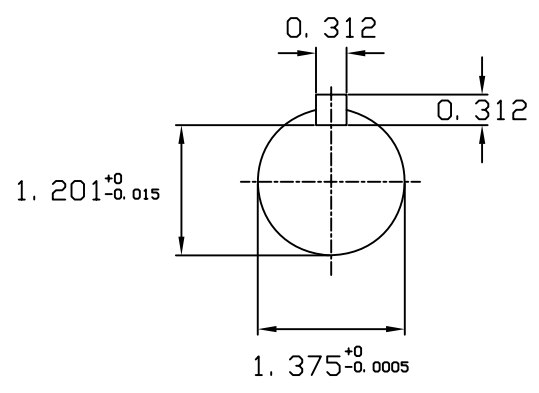
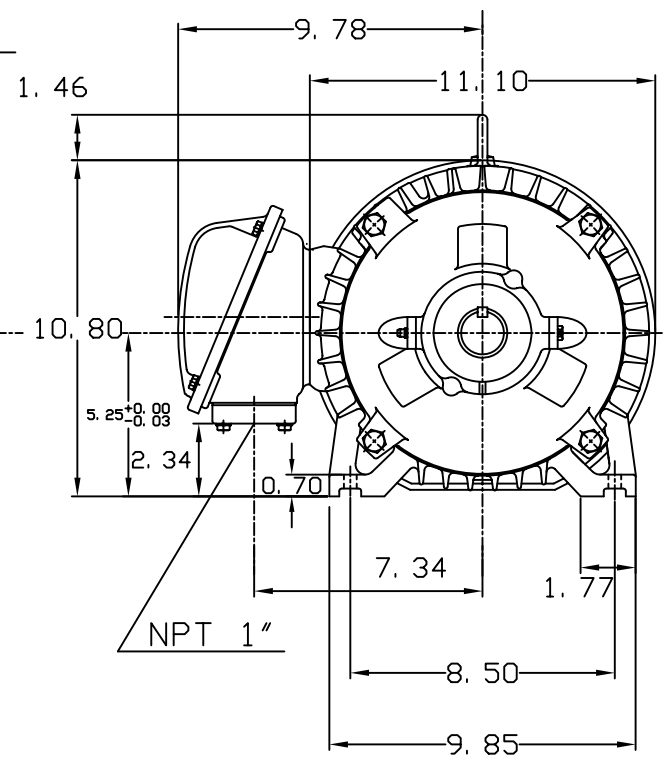
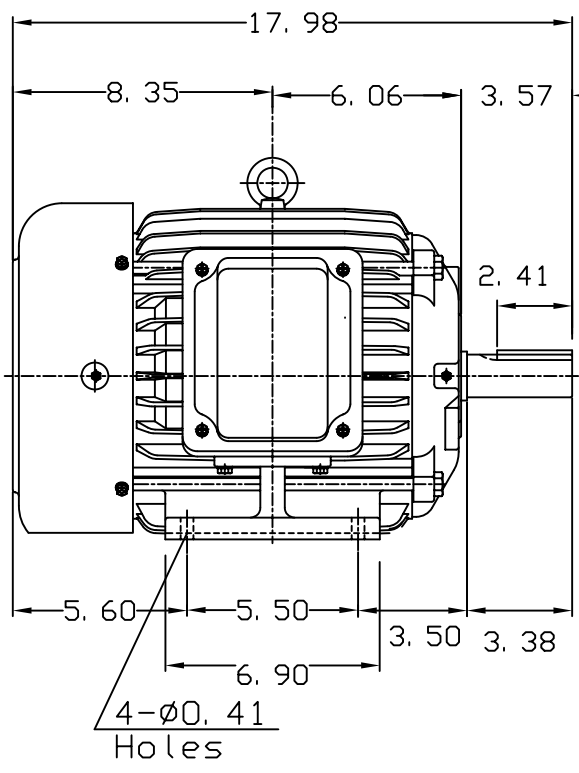

① 10.30.00 J. H. LIANG

DWN.	J. H. LIANG	11-30-98
CHKD.	C. S. LO	12-29-98
APPD.	Y. B. HUANG	12-29-98



DWG NO.  
31057H355004