

DATE
JAN. 4, 2007
CAT. #: EPV0304C-50

OUTLINE DIMENSIONS
3-PHASE INDUCTION MOTOR

MOTOR TYPE:
AEUH8NDC
FRAME NO. 286TC

Pole	HP	kW	Hz	VOLT	Syn. Speed r/min(rpm)
4	30	22	50	190/380	1500

Ins	Rating	Dimension in	Approx Weight	Bearings
F	CONT.	inches	495 LBS	DE: 6311ZZ NDE: 6310ZZ

Totally Enclosed Fan-Cooled Vertical Type, Squirrel-cage Rotor.

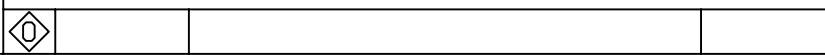
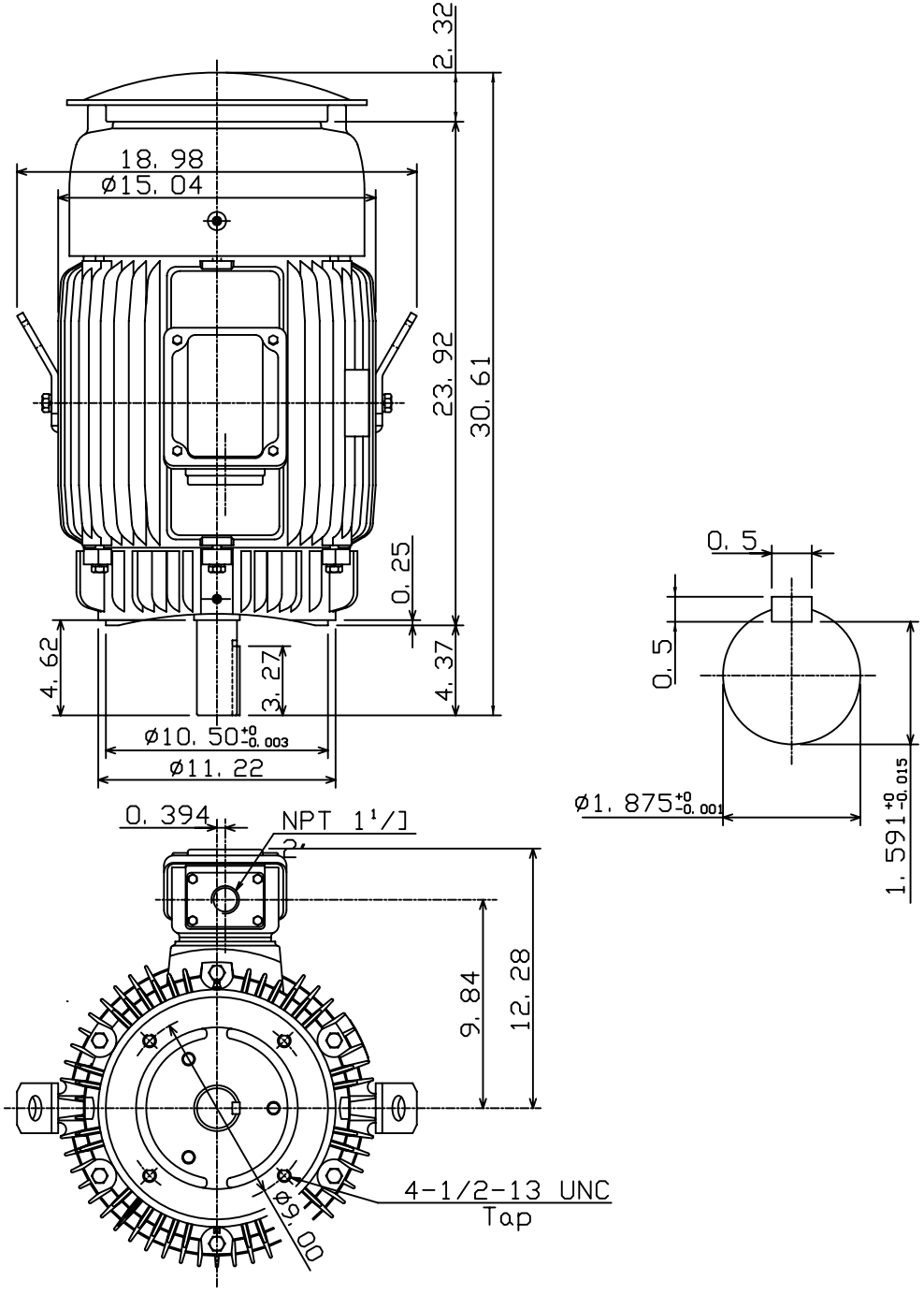

DWN.	K. L. KUO	12-30-06
CHKD.	K. L. KUO	01-02-07
APPD.	M. C. TSAI	01-02-07



DWG NO.
31057H316310