

TYPE	OUTPUT		POLE	TIME RATING	VOLTAGE V	Hz	SYN. SPEED R.P.M
	HP.	kW.					
AEHHSY	250	187	6	CONT.	460	60	1200

TOTALLY ENCLOSED FAN-COOLED TYPE. SQUIRREL-CAGE ROTOR

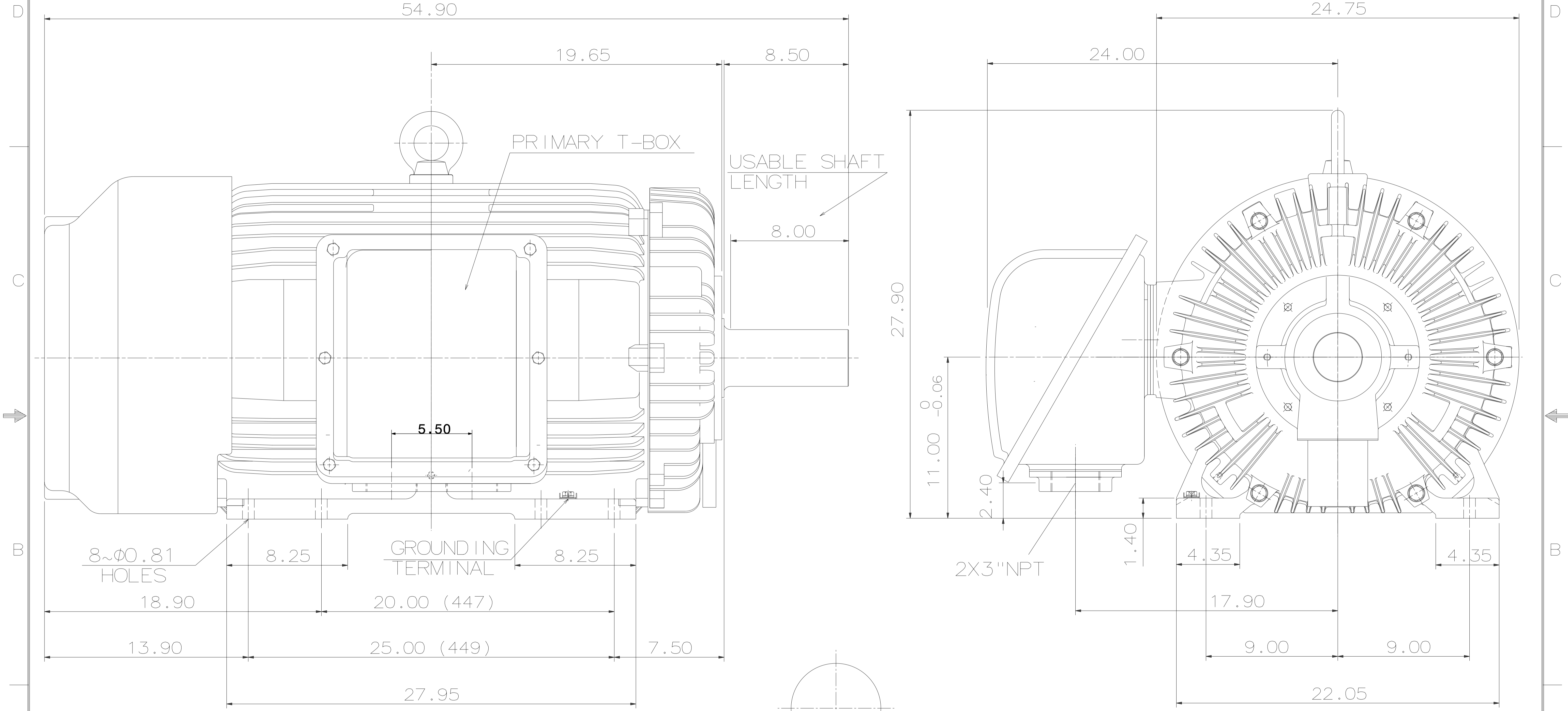

- NOTE:
1. DIMENSIONS IN INCH.
 2. FRAME NO. 449TY
 3. F CLASS INSULATION, S.F.1.15
 4. FOR DIRECT FLEXIBLE COUPLING
 5. ENCLOSURE: IP55
 6. BEARING SIZE: DRIVE-END 6224
OPP. DRIVE-END 6316
 7. MOTOR APPROX. WEIGHT: 2675 LBS

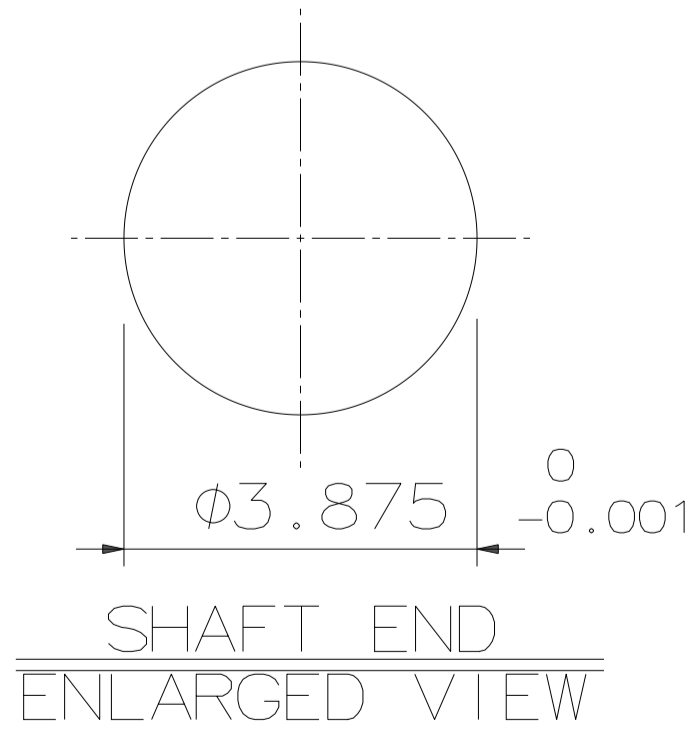

DATE	12/7/15	OUTLINE DIMENSIONS	
CATALOG#	EPY2506	3-PHASE INDUCTION MOTOR	
TECO Westinghouse		DWG NO.	REV: 00
		31057C547651	

DWN.	S.H.SHEN	03-07-14
CHKD.	S.H.SHEN	03-07-14
APPD.	C.H.SHYU	03-07-14