

DATE
JAN 19, 2012

CATALOG NO.
GHV0/52C

OUTLINE DIMENSIONS
3-PHASE INDUCTION MOTOR

MODEL TYPE:
AETHCF

FRAME NO. 56C

Pole	HP	KW	Hz	VOLT	Syn. Speed R. P. M
2	1/2	.37	60	230/460	3600

Ins.	Rating	Dimensions in	Approx Weight	Bearings
F	CONT.	inch	25 lbs.	DF: 6204ZZ NDE: 6203ZZ

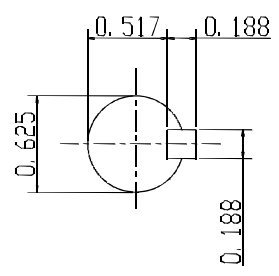
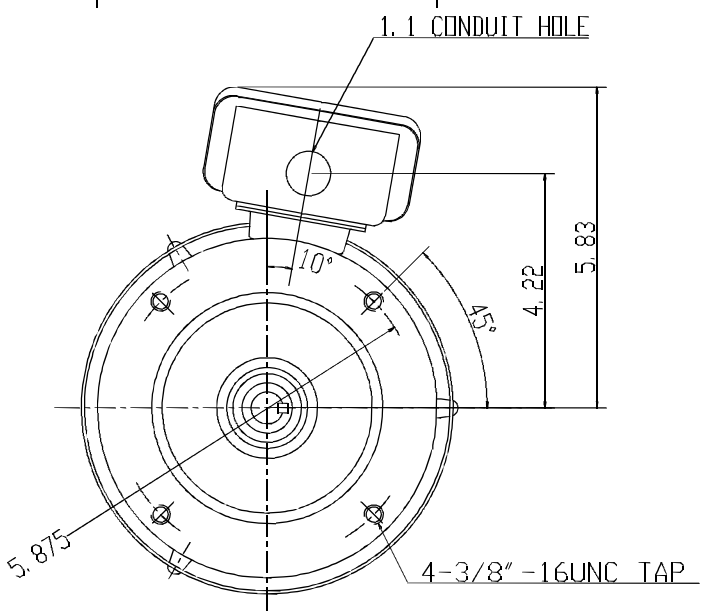
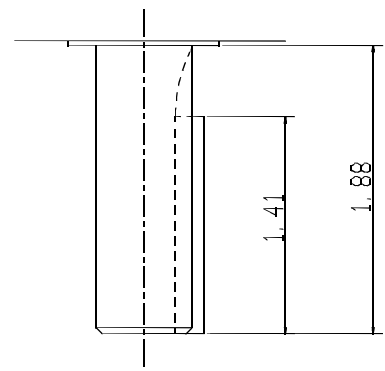
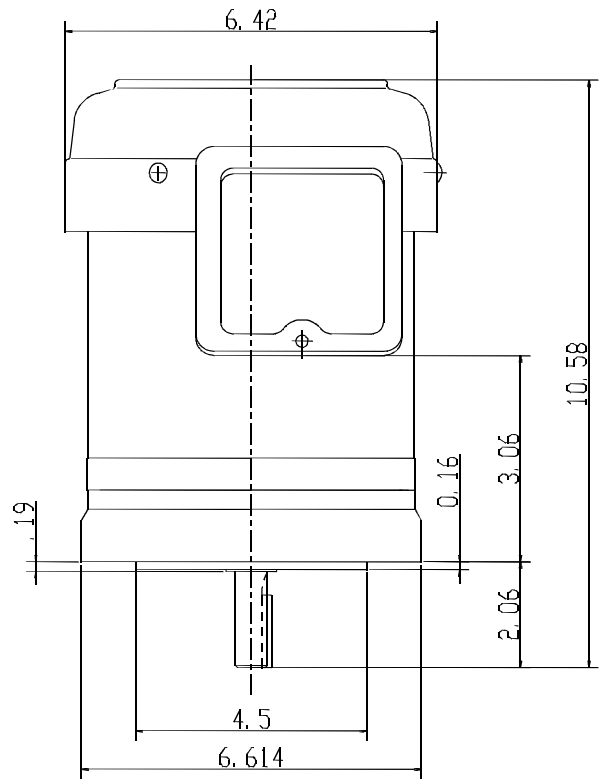

--	--	--	--	--	--	--	--

APPD.	W. H. TSAT	03 31 03
CHKD.	J. B. CHEN	03 31 03
DWN.	P. J. CHEN	03 31 03



DWG NO.
31049Z105
0724