

DATE  
Nov. 7, 2018  
Cat. #: JPP0034

# OUTLINE DIMENSIONS

## 3-PHASE INDUCTION MOTOR

MOTOR TYPE:  
AEHH8NJP  
FRAME NO. 182JP

Pole	HP	kW	Hz	VOLT	Syn. Speed r/min(rpm)
4	3	2.24	60	230/460	1800

Ins	Rating	Dimension in	Approx Weight	Bearings
F	CONT.	inches	106 lbs.	DE: 6307ZZ NDE: 6306ZZ

Totally Enclosed Fan Cooled Type. Squirrel Cage Rotor.

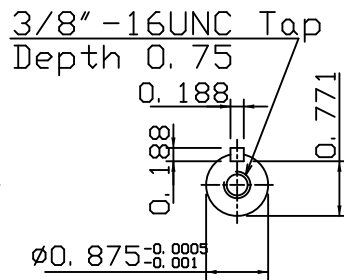
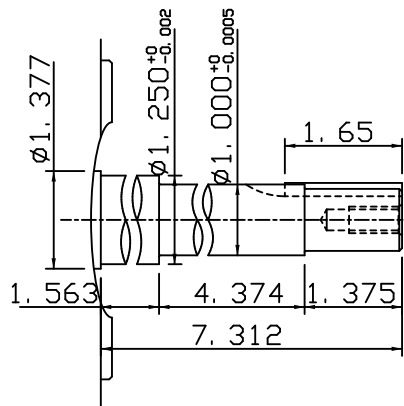
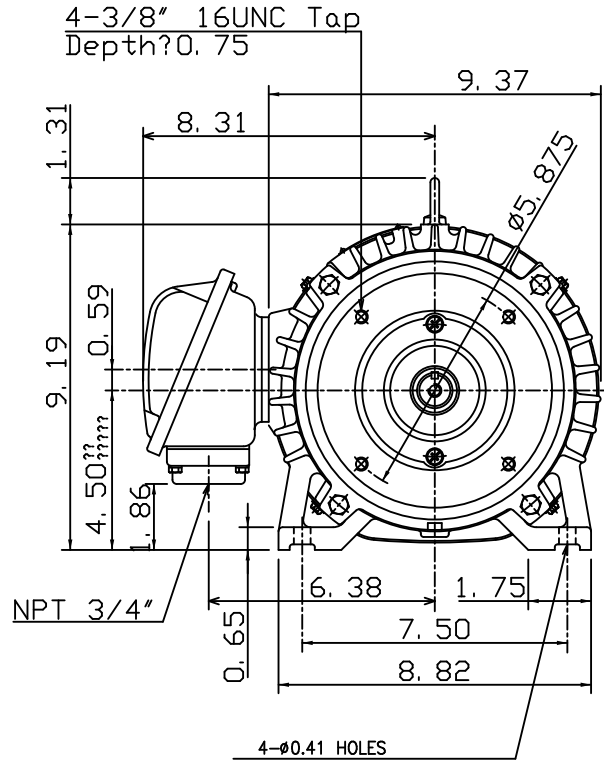
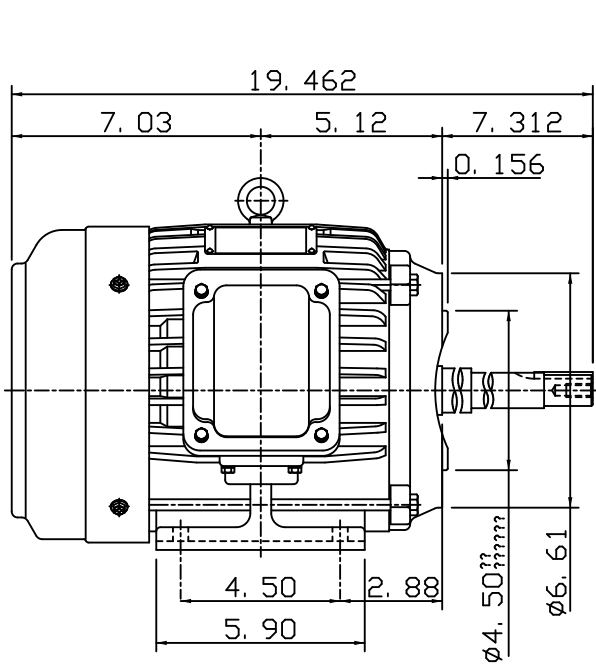

DWN.	J. H. LIANG	01-11-18
CHKD.	H. C. YAN	02-12-18
APPD.	M. C. TSAI	02-12-18



DWG NO.  
31049H739040