

DATE  
Nov. 7, 2008  
Cat. #: JPP0254

OUTLINE DIMENSIONS  
3-PHASE INDUCTION MOTOR

MOTOR TYPE:  
AEHH8NJP  
FRAME NO. 284JP

Pole	HP	kW	Hz	VOLT	Syn. Speed r/min(rpm)
4	25	18.7	60	230/460	1800
Ins	Rating	Dimension in	Approx Weight	Bearings	
F	CONT.	inches	420 lbs.	DE: 6311ZZ	NDE: 6310ZZ

Totally Enclosed Fan-Cooled Type, Squirrel-Cage Rotor.

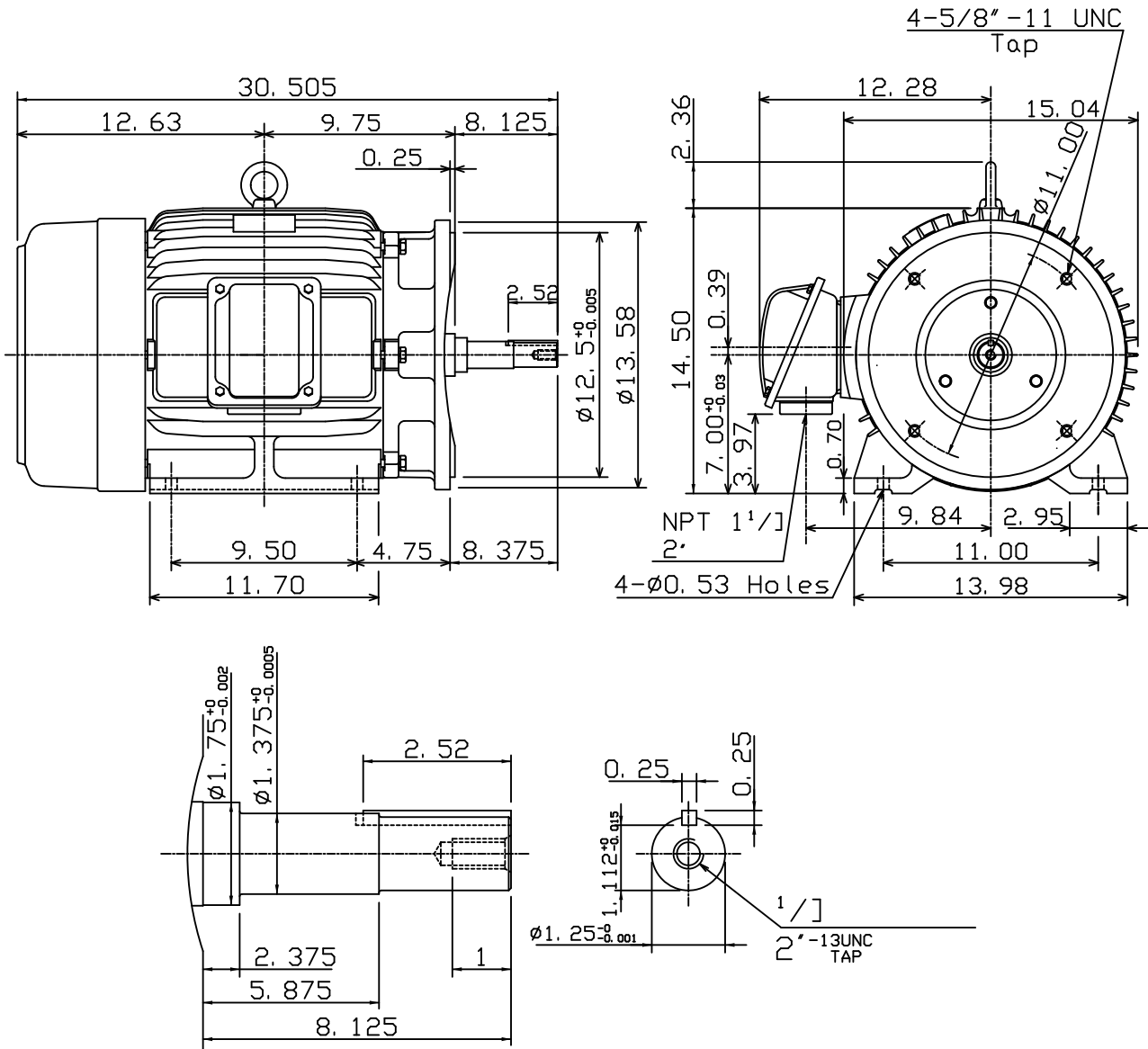

DWN.	K. L. KUO	02-13-08
CHKD.	K. L. KUO	02-14-08
APPD.	M. C. TSAI	02-14-08

TEC Westinghouse

DWG NO.  
31057H206820