

TYPE	OUTPUT		POLE	TIME RATING	VOLTAGE V	Hz	SYN. SPEED R.P.M
	HP.	kW.					
AEHAGD	125	93.2	8	CONT.	2300/4000	60	900

TOTALLY ENCLOSED FAN-COOLED TYPE. SQUIRREL-CAGE ROTOR

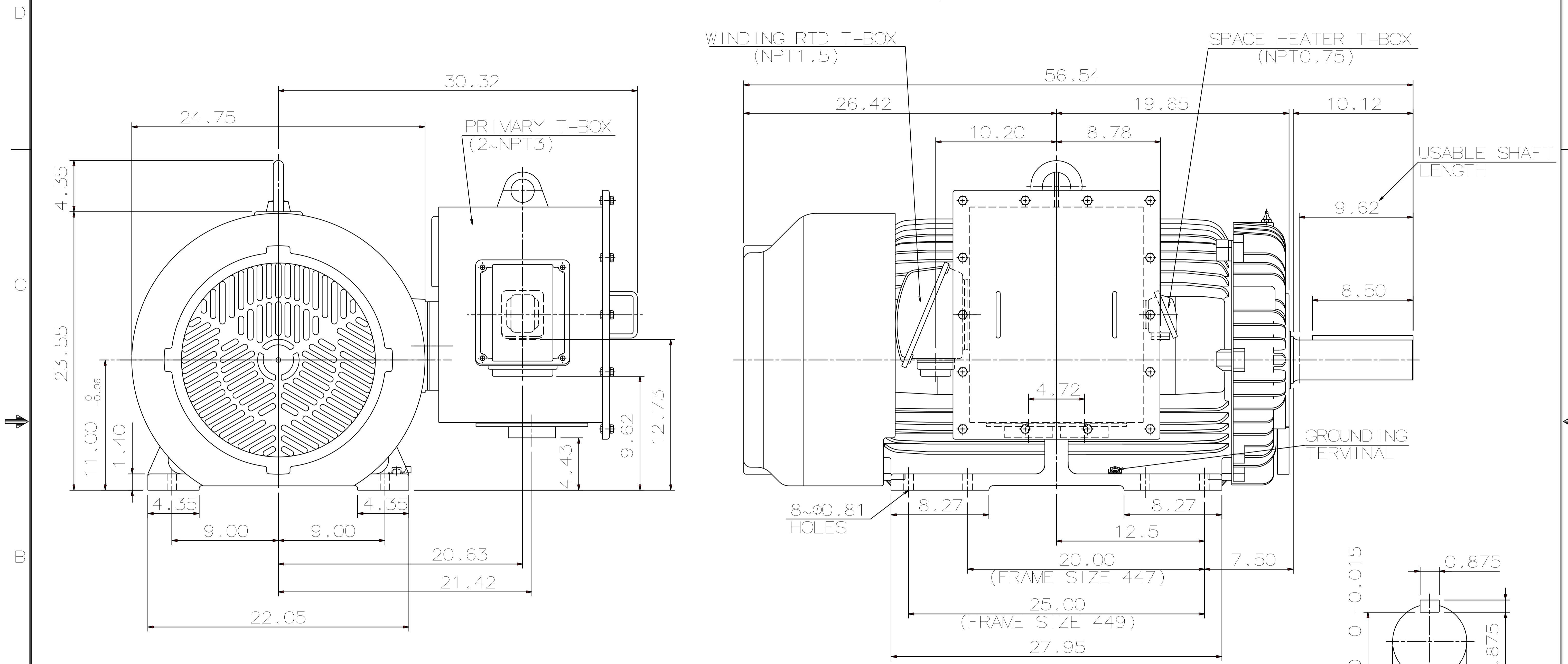

NOTE:

1. DIMENSIONS IN inch
2. FRAME NO. 449TZ
3. F CLASS INSULATION, S.F.1.15
4. FOR BELT DRIVE
5. ENCLOSURE: IP55
6. BEARING SIZE: DRIVE-END NU320C3
OPP. DRIVE-END 6316
7. WITH WINDING RTD: PT 100Ω/0°C 6PCS
8. WITH SPACE HEATER: SINGLE PHASE, 120V
9. NON-SPARKING FAN
10. CORROSION PROOF
11. APPROXIMATE WEIGHT: 2,575 LBS

DWN.	J. CHANG	MAY. 22. 2015
CHKD.	H. HUANG	MAY. 22. 2015
APPD.	C. LIU	MAY. 22. 2015

DATE DEC 08 2016	OUTLINE DIMENSIONS	
KD1258R	3-PHASE INDUCTION MOTOR	
TEC Westinghouse		DWG NO. REV: 00 4B040M519