

CATALOG #	TYPE	FRAME	OUTPUT		POLE	SYN. SPEED R.P.M.	VOLTAGE V.	Hz.	TIME RATING	INSULATION CLASS	SERVICE FACTOR	BEARINGS		WEIGHT LBS
			HP	KW								DE	NDE	
PG2502	AMHG	449TS	250	186.4	2	3600	2300/4160	60	CONT.	F	1.15	6315C3	6315C3	2020

WEATHER PROTECTED TYPE I. SQUIRREL CAGE ROTOR

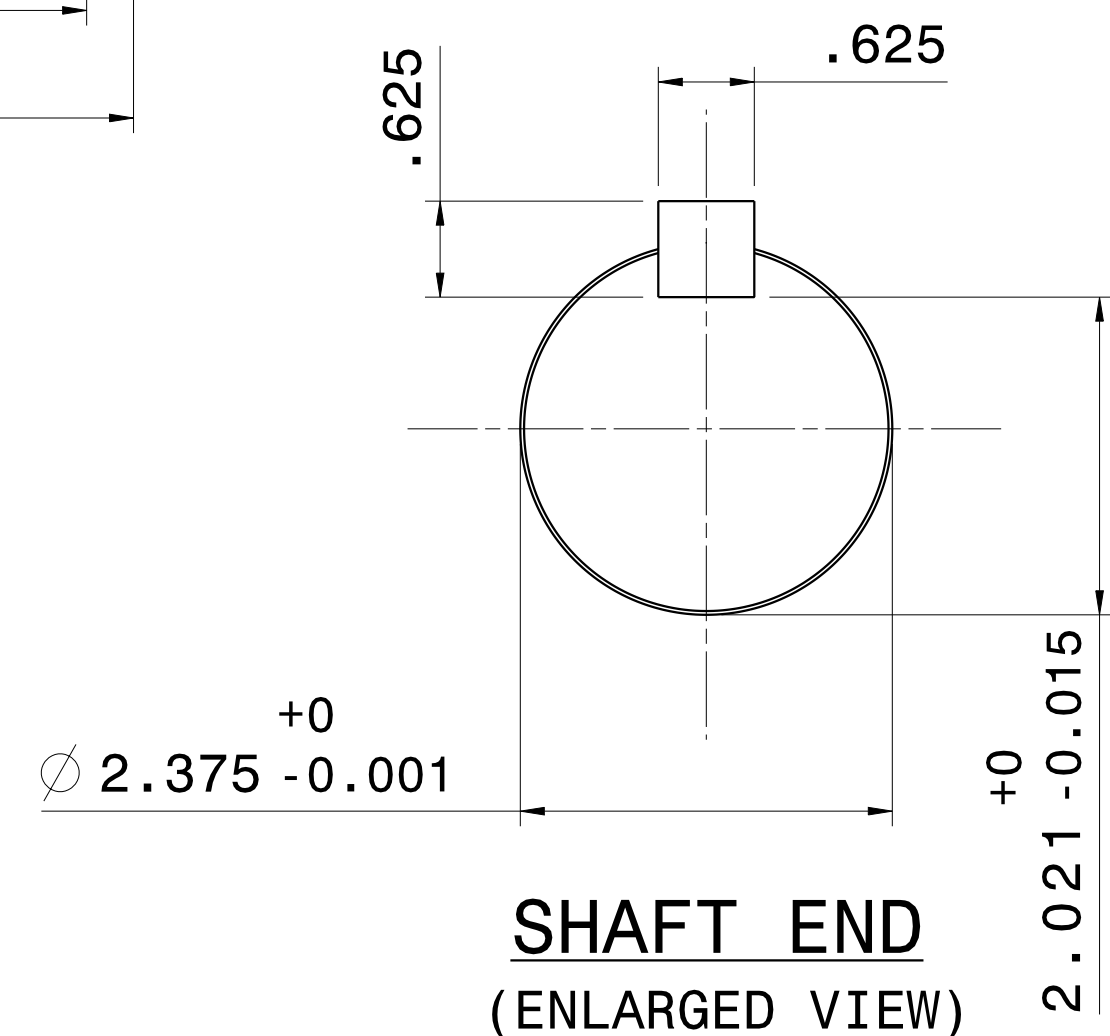
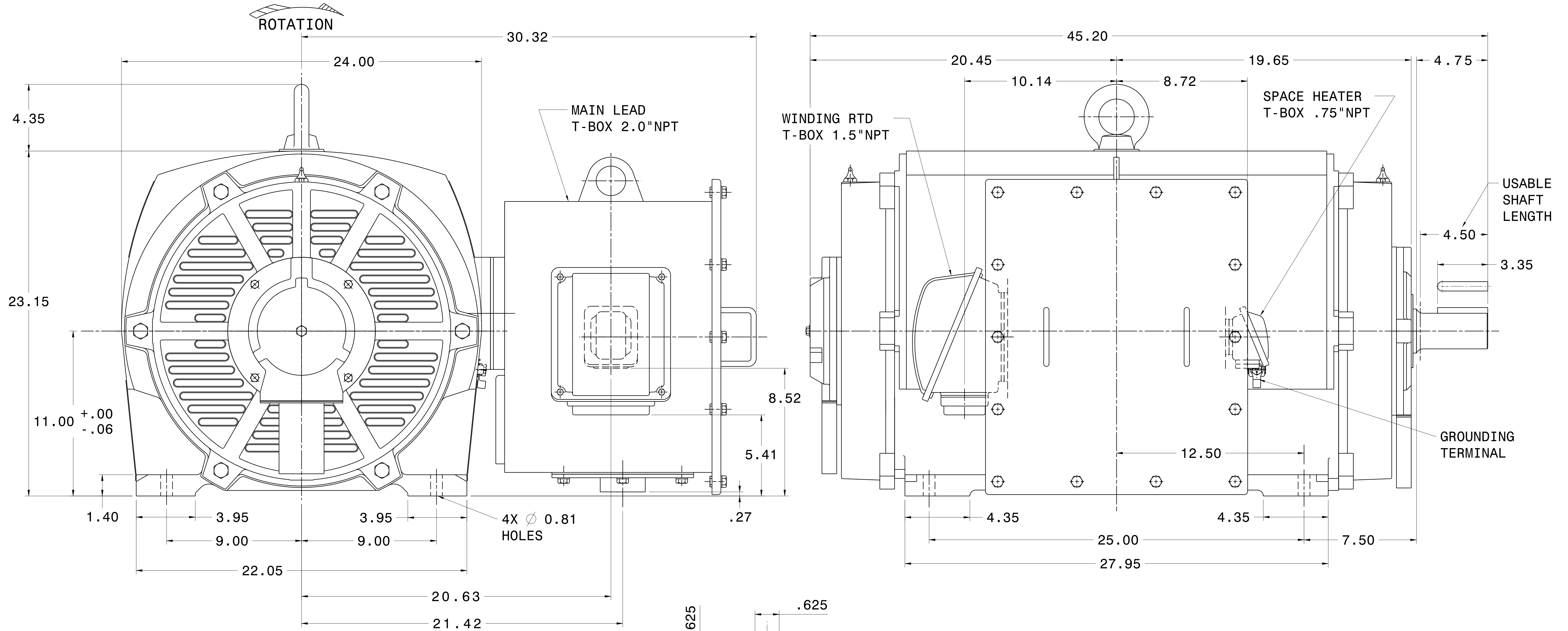

- NOTES:
1. DIMENSIONS IN INCH.
 2. ENCLOSURE: IP23.
 3. FOR DIRECT FLEXIBLE COUPLING.
 4. SPACE HEATER RATED 120 VOLT, SINGLE PHASE.
 5. 100 OHM PLATINUM WINDING RTD'S, 2 PER PHASE.

REF: 4B040M465	REV. DATA	TECO Westinghouse		REV NO	01
	3-PHASE INDUCTION MOTOR OUTLINE DIMENSIONS			DWG NO.	PG2502
	DWN K. MILNER	080317	APPD T. FELPS	080317	
	TECO-WESTINGHOUSE MOTOR COMPANY		ROUND ROCK, TEXAS USA		