

TYPE	OUTPUT		POLE	TIME RATING	VOLTAGE V	Hz	SYN. SPEED R.P.M
	HP.	kW.					
AMRKNH	350	261	4	CONT	2300/4000	60	1800

ENCLOSED VENTILATED VERTICAL HOLLOW SHAFT TYPE, SQUIRREL CAGE ROTOR
NEMA WEATHER PROTECTED TYPE I

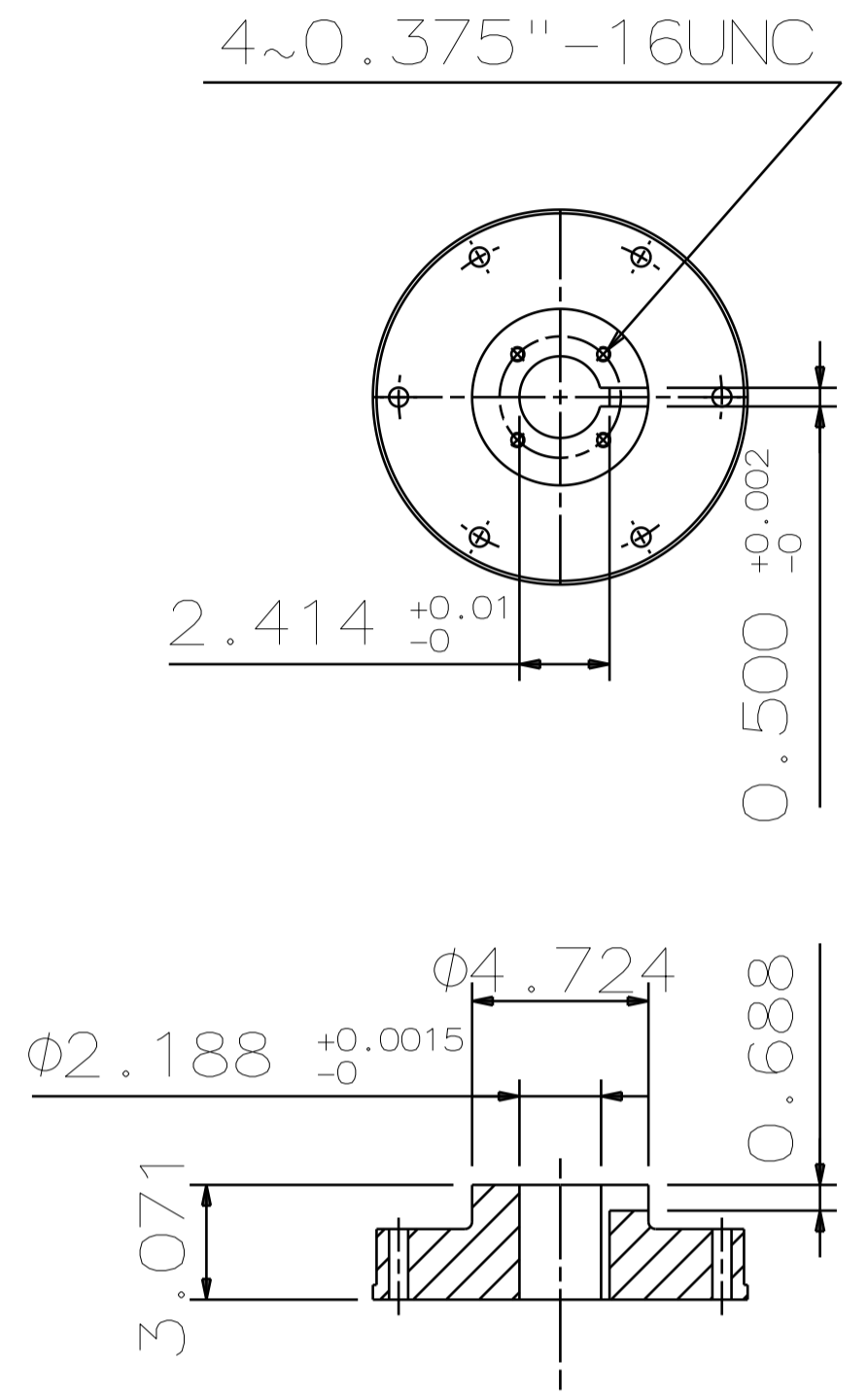

COUPLING
[ENLARGED VIEW]

NOTE:

- DIMENSIONS IN INCH
- FRAME NO.5009
- F CLASS INSULATION, S.F. 1.15
- FOR DIRECT COUPLING
- BEARING SIZE:
UPPER BEARING: 29330+6028 (INSULATED)
LOWER BEARING: 6220C3 [UNINSULATED]
- UPPER BEARING IS INSULATED. ANY METAL CONNECTIONS TO IT MUST BE INSULATED.
- LUBRICATION:
UPPER BEARING USE OIL.
OIL VISCOSITY: ISO VG68 [300 SSU/100°F]
OIL QUANTITY: 1.8 GAL.
LOWER BEARING USE GREASE. [MOBIL POLYREX EM]
- ROTATION: COUNTER-CLOCKWISE [VIEW FROM TOP].
- WITH NON-REVERSE RATCHET MECHANISM.
- WITH GIB KEY: 0.500X0.500X3.07, 1PCS
- APPROXIMATE WEIGHT: 3630
- DOWNTHRUST: 30,900 LBS (L10-8800HRS)
- REED FREQUENCY: 36 HZ
- SPACE HEATER RATED AT 120 VOLT, SINGLE PHASE, 200 WATTS, LEADS TERMINATE IN MAIN LEAD BOX.

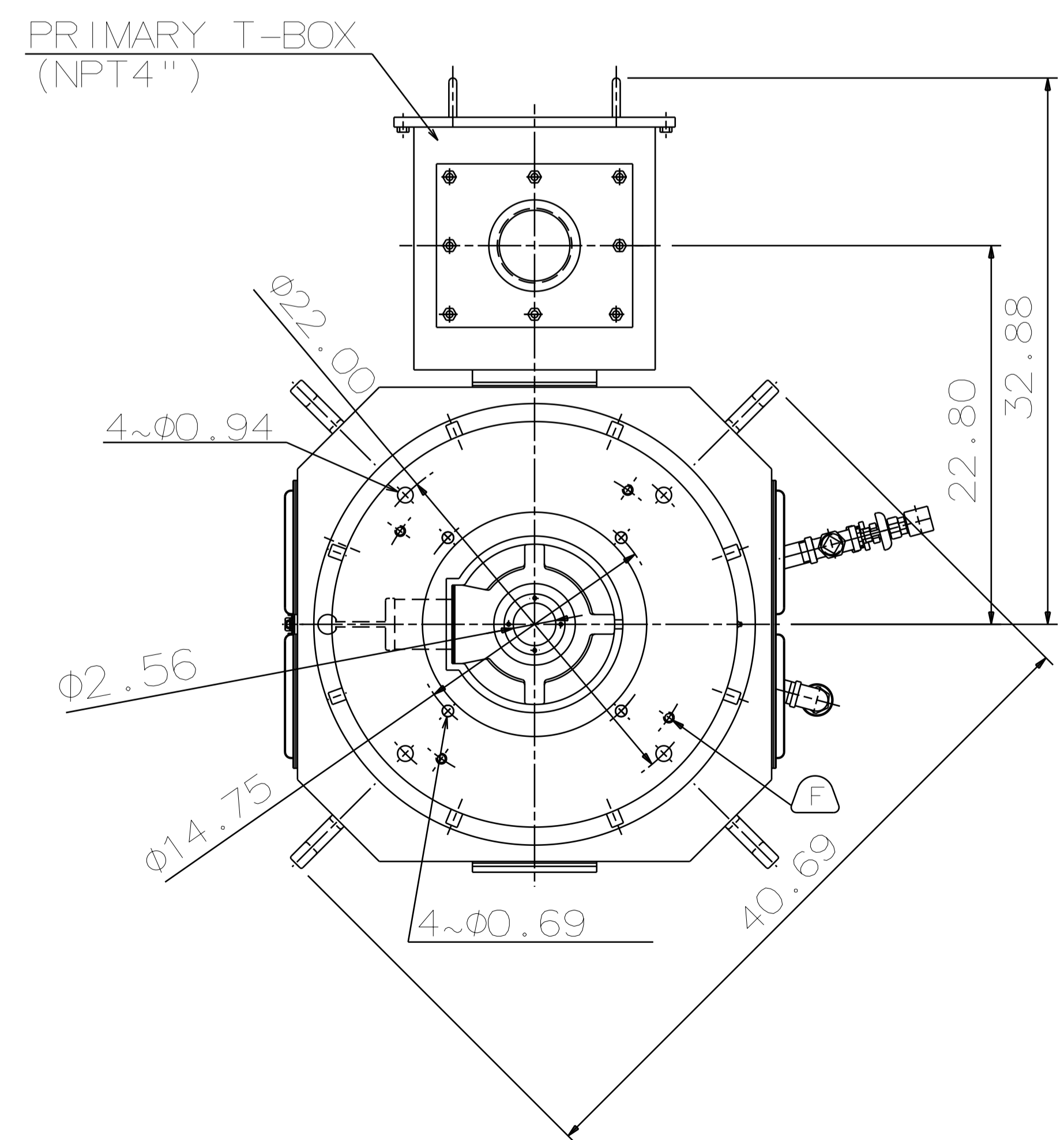

- (A) OIL FILLER [UPPER BEARING]
- (B) OIL GAUGE [UPPER BEARING]
- (C) OIL DRAIN [UPPER BEARING]
- (D) GREASE INLET [LOWER BEARING]
- (E) GREASE DISCHARGER [LOWER BEARING]
- (F) 4~M16 VERTICAL JACKING HOLES, 90°APART IN MOTOR BASE.
- (G) M10 TAPPED GROUNDING ON FRAME, WITH ONE GROUNDING STUDS & [R38-10] TERMINAL LOCATED AS SHOWN.

DATE	DEC 08 2016	OUTLINE DIMENSIONS	
	VHKP3504	3-PHASE INDUCTION MOTOR	
DWN.	Y. YANG	JUN.02.2015	DWG NO. REV:00
CHKD.	R. LEE	JUN.02.2015	4B040L480
APPD.	C. LIU	JUN.02.2015	



DWN.	Y. YANG	JUN.02.2015
CHKD.	R. LEE	JUN.02.2015
APPD.	C. LIU	JUN.02.2015