

CATALOG #	TYPE	FRAME	OUTPUT		POLE	SYN. SPEED R.P.M.	VOLTAGE V.	Hz.	INSULATION CLASS	SERVICE FACTOR	BEARINGS		WEIGHT LBS
			HP	kW							DE	NDE	
WFNO/74C	TENV	A56C	0.75	0.56	4	1800	230/460	60	F	1.15	6205ZZ	6205ZZ	39 LBS.

TOTALLY ENCLOSED NOT VENTILATED TYPE. SQUIRREL CAGE MOTOR

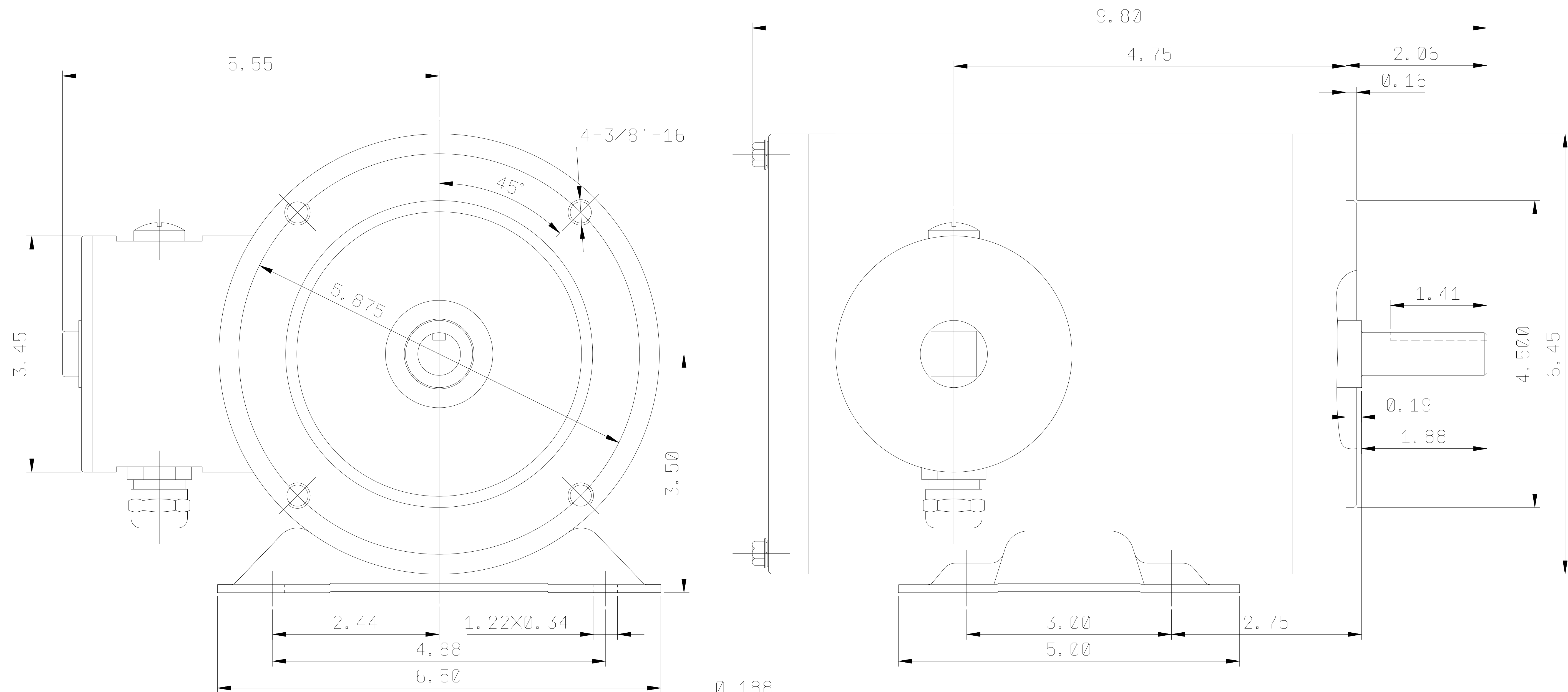

- NOTES: 1. DIMENSIONS IN INCH.
 2. ENCLOSURE: IP66.
 3. FOR DIRECT FLEXIBLE COUPLING.
 4. STAINLESS STEEL CONSTRUCTION.

REF: 31049J806230	REV. DATA		
	TECO Westinghouse		REV NO 01
	3-PHASE INDUCTION MOTOR OUTLINE DIMENSIONS		DWG NO. WFNO/74C
	DWN C. COOK	092420	
TECO-WESTINGHOUSE MOTOR COMPANY		ROUND ROCK, TEXAS	USA